

Powered by Experience.
Driven by Excellence.™

ADT Commercial

Proposal



Proposal prepared for:

MCA

Presented by:

Nathan Ishum

720-665-1083 | 2/2/2023

Sales Agreement ID: 891556753

Proposal pricing is valid for 30 days

Powered by Experience. Driven by Excellence.

















What helps make us an industry leader is plain and simple—we strive to deliver an outstanding customer experience at all points of interaction.

Coverage across the US

We have a national footprint with 150 locations, 4,500+ employees, 300,000+ customer locations, and 4 monitoring and operations centers.



Product and service offerings

- | | |
|---|--|
|  Access Control |  Intrusion Alarm Systems |
|  Alarm Monitoring |  Network Deployment & Management |
|  Analytics & Reporting |  Risk Management Consulting Services |
|  ATM & ITM |  Security-Only Networks |
|  eSuite SM Account Management |  Sprinkler Systems <i>(in select markets)</i> |
|  Fire Alarm Systems |  Structured Cabling |
|  Health & Nurse Call |  System Customization, Installation & Support |
|  Hosted & Managed Services |  Video Solutions |
|  Integrated Solutions | |

Integrated system design and implementation offerings

- Managed broadband and MPLS
- Design-build engineering
- Wireless network security
- Tier 2 and Tier 3 support 24/7
- Network security
- Program and project management
- Data storage systems
- Security consulting and design assistance
- Cloud backup and disaster recovery
- Security network design assistance, implementation and management
- Structured cabling

Thursday, February 2, 2023

MCA

8351 E Northfield Blvd
DENVER, CO 80238

Thank you for allowing us the opportunity to provide you with a proposal for your system. I am pleased to propose a cost effective solution for your organization that will allow you to help mitigate your risks and reduce losses.

At ADT Commercial, we pride ourselves in providing our commercial customers with attentive service, proven security solutions, and the highest level of professional installation and monitoring.

I look forward to discussing this proposal with you. Should you have any questions, please do not hesitate to contact me.

Sincerely,

Nathan Ishum

720-665-1083 / NathanIshum@adt.com

ADT Commercial Will Provide and Install an Intrusion System Per Site Including:

- (1) DMP XR150 Panel
- (1) Keypad
- (1) Cell Communicator
- (1) Wireless Receiver
- (6) Door Contacts with Wireless Transmitters
- (4) Wireless PET PIR Motion Detectors

Notes:

Monthly Costs Are for Site Monitoring, Signaling, and virtual keypad
Any Additional Work Required Will Be Addressed Via a Change Order
Point of Contact for ADT Will Be Nathan Ishum at (720) 665-1083

Exclusions:

Pricing assumes all existing alarm wiring and hardware is in working condition, and is excluded, unless otherwise noted elsewhere. Any additional service needed to troubleshoot will be billed at an additional \$135/technician hour.

CUSTOMER will be responsible for providing any 110VAC required for the proper operation of the equipment.

CUSTOMER will be responsible for providing and installing network connection within 6 feet of the equipment.

Additional labor or equipment not listed in this proposal.

Any needed patching/painting of sheetrock required due to the cutting of access holes for cabling to be provided by client

The cost for the alarm permit, false alarm permit, electrical permit, or lift rental is not included in the final prices. These costs will be billed to the CUSTOMER separately (if needed).

The cost for the drawings is not included in the final prices. These costs will be billed to the CUSTOMER separately (if needed).

Conduit and back boxes excluded (if needed), by electrical contractor or these costs will be billed to the CUSTOMER separately (if needed).

Penetrations between floors (if needed), by customers contractor or these costs will be billed to the CUSTOMER separately (if needed).

TAXES: The Customer shall be responsible for all taxes applicable to the work and/or materials hereunder.

WORK HOURS: Seller will perform all work during normal business hours: Monday through Friday, 8:00AM - 05:00PM. Any requests for work to be performed outside normal business hours will be billed at Seller premium rates in effect at the time the work is performed.

Alarm operation assumes sufficient cell phone signal at alarm panel location. If this is not the case, extension antenna options are available at additional cost.

ADT Commercial Will Provide and Install A Video Surveillance System Per Site Including:

- (1) Hanwha 8 Channel PoE NVR with 12TB of Storage
- (4) Wave Professional Video Management Licenses
- (1) UPS
- (1) 22" Monitor
- (4) PNV-A6081R 2MP AI Cameras
- (1) Altronix Power Supply
- (2) Exterior Speaker/Strobes

See attached data sheet for camera capabilities.

ADT Commercial will install new system as standalone and set up remote access for customer.

Notes:

Any Additional Work Required Will Be Addressed Via a Change Order

Point of Contact for ADT Will Be Nathan Ishum at (720) 665-1083

Exclusions:

Pricing assumes all existing alarm wiring and hardware is in working condition, and is excluded, unless otherwise noted elsewhere. Any additional service needed to troubleshoot will be billed at an additional \$135/technician hour.

CUSTOMER will be responsible for providing any 110VAC required for the proper operation of the equipment.

CUSTOMER will be responsible for providing and installing network connection within 6 feet of the equipment.

Additional labor or equipment not listed in this proposal.

Any needed patching/painting of sheetrock required due to the cutting of access holes for cabling to be provided by client

The cost for the alarm permit, false alarm permit, electrical permit, or lift rental is not included in the final prices. These costs will be billed to the CUSTOMER separately (if needed).

The cost for the drawings is not included in the final prices. These costs will be billed to the CUSTOMER separately (if needed).

Conduit and back boxes excluded (if needed), by electrical contractor or these costs will be billed to the CUSTOMER separately (if needed).

Penetrations between floors (if needed), by customers contractor or these costs will be billed to the CUSTOMER separately (if needed).

TAXES: The Customer shall be responsible for all taxes applicable to the work and/or materials hereunder.

WORK HOURS: Seller will perform all work during normal business hours: Monday through Friday, 8:00AM - 05:00PM. Any requests for work to be performed outside normal business hours will be billed at Seller premium rates in effect at the time the work is performed.

Alarm operation assumes sufficient cell phone signal at alarm panel location. If this is not the case, extension antenna options are available at additional cost.

Summary of Charges for: MCA Video Surveillance		
Aviator Pool	Installation Price	\$15,745.50
F-15 Pool	Installation Price	\$15,745.50
Jet Stream Pool	Installation Price	\$15,745.50
Maverick Pool	Installation Price	\$15,745.50
Puddle Jumper Pool	Installation Price	\$15,745.50
Runway 35 Pool	Installation Price	\$15,745.50
Splash Landing Pool	Installation Price	\$15,745.50
	Total	\$110,218.50

Summary of Charges for: MCA Intrusion Alarm		
Aviator Pool	Installation Price	\$3,500.00
F-15 Pool	Installation Price	\$3,500.00
Jet Stream Pool	Installation Price	\$3,500.00
Maverick Pool	Installation Price	\$3,500.00
Puddle Jumper Pool	Installation Price	\$3,500.00
Runway 35 Pool	Installation Price	\$3,500.00
Splash Landing Pool	Installation Price	\$3,500.00
	Total	\$24,500.00

Proposed Total	
Installation Price	\$134,718.50
Estimated Install Taxes	\$8,356.50
Total	\$143,075.00

WRN-810S

Wisenet WAVE Network Video Recorder

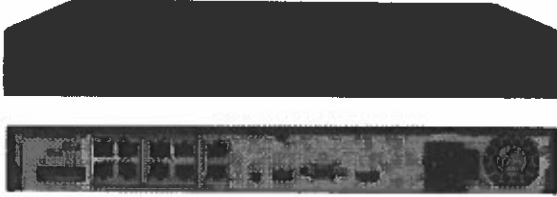

The WRN-810S is a Wisenet WAVE optimized 1U rackmounted Network Video Recorder capable of recording up to 80Mbps, managing up to 12TB of storage. The Linux Ubuntu OS is utilized for stability and quick setup.

Each is pre-configured with the Wisenet WAVE VMS Server and client, and preloaded with 4 Professional licenses to ensure quick and easy deployment with minimum setup time.

Key Features

- Preloaded and configured with Wisenet WAVE video management system (Client & Server)
- Includes (4) four Wisenet WAVE Professional licenses
- 80 Mbps of recording throughput
- Supports up to 12TB internal storage
- PoE+ camera ports, 100W Budget
- Easily control PoE port power via WAVE interface
- Includes USB mouse
- Includes rack mount brackets
- Front panel indicator lights, Alarm I/O
- Supports Wisenet and ONVIF conformant IP cameras
- Preloaded with Ubuntu Linux 18.04 LTS

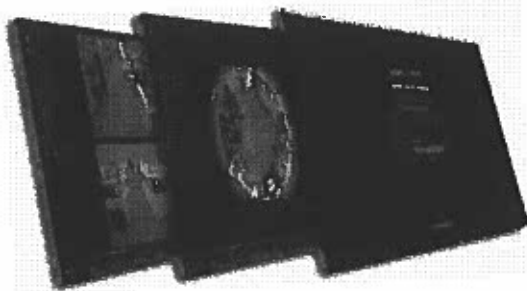

WRN-810S

SYSTEM	
Video Management Software	Wisenet WAVE
Pre-loaded Licenses	4x Wisenet WAVE Professional licenses
Recording Bandwidth	Up to 80Mbps
OS Drive Bays	1 x M.2, SSD (pre-installed)
Data Drive Bays	2 x 3.5" SATA HDDs
Data Storage	Supports up to 12TB raw
Indicator Lights	Power, Alarm, HDD, Network, Record, PoE Over Budget
Network Interface	2x RJ-45, GigaBit Ethernet, 8x PoE+ 100Mbps
Alarm I/O	4x Alarm Input / 2x Alarm Output
PoE Camera Ports	8x 100Mbps, Maximum 30W 80% per PoE+, Total Budget 100W
Operating System	Linux Ubuntu 18.04 LTS
Video Outputs	1x HDMI 4K (pass), 1x VGA 1080p (pass) *System Config & Basic Monitoring
USB Ports	1x USB 3.0 (rear), 1x USB 2.0 (front)
Other Ports	3.5mm stereo audio-out
Mouse	Included
Rack Mount Brackets	Included

MECHANICAL / ELECTRICAL / ENVIRONMENTAL

MECHANICAL / ELECTRICAL / ENVIRONMENTAL		
Mechanical	Form Factor	1U rackmount chassis
	Color / Material	Black / Metal
	Dimensions	14.5" (427) x 12.7" (322)mm ± 0.25mm (0.01")
	Weight	5.9 lbs (2.7 kg) without hard drive
Electrical	Power Supply	106W maximum with 2 HDD, Maximum PoE: 37W, 2 HDDs, PoE Off
	Power Input	100 - 240V AC
Environmental	Operating Temperature	32°F to 104°F (0°C to 40°C)
	Operating Humidity	20% to 85% RH, non-condensing
Certification	UL, CE, FCC	

* Weight is on chassis without HDDs
 * The latest product information / specification can be found at www.hanwha-security.com
 * Bandwidth performance figures based on performance testing by Hanwha Technwin using Wisenet WAVE

***Please note:**
 - Local WAVE Client is intended for system configuration and basic monitoring.
 - Remote viewing / playback from dedicated client is recommended for best experience.
 - Recommended maximum of 30 servers for merged systems.

Dimensions

Unit: mm (inch)

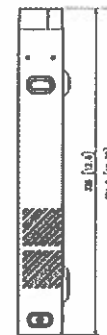
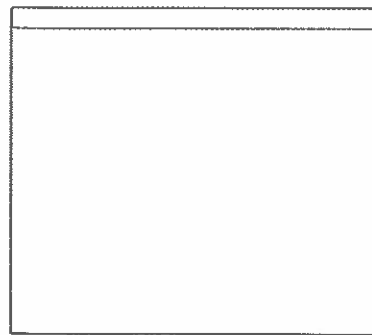
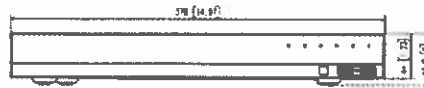



Network Dome

PNV-A6081R

2MP AI IR Vandal Dome Camera

FC | | CE | ENEC |

Key Features

- Maximum 2MP resolution. Up to 120fps
- 0.007Lux@F1.3, 1/30sec. (Color), 0Lux (B/W, IR LED on)
- Day & Night (ICR), WDR (120dB), WiseNR II (Using AI engine)
- H.265, H.264, MJPEG, WiseStream II, WiseStreamIII (Using AI engine)
- Video Analytics based on AI
 - Object detection and classification (Person, Face, Vehicle, License Plate)
 - Face mask detection, Social distancing detection
 - Attribute, BestShot
- TPM with FIPS 140-2 level2. Secure boot. Verify firmware forgery
- System requirements
 - SSM v2.10.8 or later, Genetec plugin v1.0 or later, Milestone plugin v1.0.2 or later, NVR model (XRN-6410DB4/B4, XRN-3210B4)
- Hard-coated dome bubble/IP66, IP67, IP6K9K, IK10+, NEMA4X

Compatible Accessories (Optional)

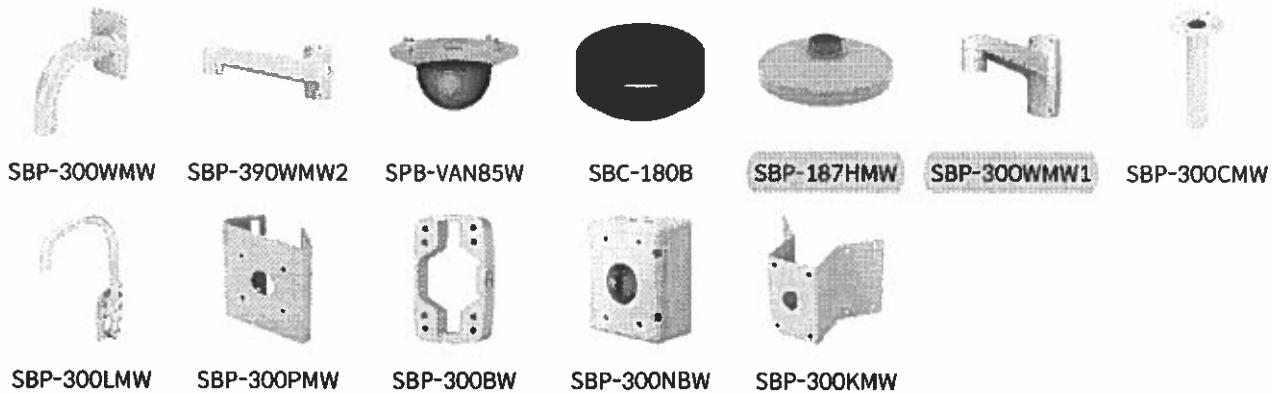

PNV-A6081R

2MP AI IR Vandal Dome Camera



Specifications

Video	
Imaging Device	1/2" CMOS
Resolution	1920x1080, 1280x1024, 1280x960, 1280x720, 1024x768, 800x600, 800x448, 720x576, 720x480, 640x480, 640x360
Max. Framerate	H.265/H.264: Max. 60/50fps(60Hz/50Hz, AI analytics on), Max. 120/100fps(60Hz/50Hz, AI analytics off) MJPEG: Max. 15fps/12fps(60Hz/50Hz)
Min. Illumination	Color: 0.007Lux(F1.3, 1/30sec, 30IRE) B/W : 0.0007Lux(F1.3, 1/30sec, 30IRE), 0Lux(IR LED on), 30/25fps Color: 0.014Lux(F1.3, 1/60sec, 30IRE) B/W : 0.0014Lux(F1.3, 1/60sec, 30IRE), 0Lux(IR LED on), 60/50fps Color: 0.028Lux(F1.3, 1/120sec, 30IRE) B/W : 0.0028Lux(F1.3, 1/120sec, 30IRE), 0Lux(IR LED on), 120/100fps
Video Out	CVBS: 1.0 Vp-p / 75Ω composite, 720x480(N), 720x576(P) for installation USB: Micro USB Type B, 1280x720 for installation

Lens	
Focal Length (Zoom Ratio)	4.38-9.33mm(2.13x) motorized varifocal
Max. Aperture Ratio	F1.3(Wide)-F2.15(Tele)
Angular Field of View	H:103.1°(Wide)-44.5°(Tele) / V:54.2°(Wide)-24.9°(Tele) / D:124°(Wide)-51.1°(Tele)
Min. Object Distance	0.5m(1.64ft)
Focus Control	Simple focus
Lens Type	P iris

Pan / Tilt / Rotate	
Pan / Tilt / Rotate Range	0-360 / -45-85 / 0-355

Operational	
Camera Title	Displayed up to 85 characters
Day & Night	Auto(ICR)
Backlight Compensation	BLC, WDR, SDR
Wide Dynamic Range	120dB
Digital Noise Reduction	SSNR, WiseNR II (using AI engine)
Digital Image Stabilization	Stabilization Support(built-in gyro sensor)
Motion Detection	8ea. polygonal zones
Privacy Masking	6ea. rectangle zones - Color: Gray/Green/Red/Blue/Black/White
Gain Control	Low / Middle / High
White Balance	ATW / AWC / Manual / Indoor / Outdoor
LDC	Support
Electronic Shutter Speed	Minimum / Maximum / Anti flicker (1/5~1/12,000sec) Auto prefer shutter control based on AI engine
Video Rotation	Flip, Mirror, Hallway view(90/270)
Analytics	Classified object type : Person/Face/Vehicle/License plate Attributes : Person(Gender, Color and Bag), Face(Age, Gender, Mask and Glasses), Vehicle(Type:car/bus/truck/motorcycle/bicycle and Color) Support Bestshot per object Analytics events based on AI engine - Object detection, Virtual line*(Crossing/Direction), Virtual area*(Loitering/Intrusion/Enter/Exit), Face mask detection, Digital auto tracking, Social distancing detection Analytics events - Defocus detection, Motion detection, Tampering, Audio detection, Sound classification, Shock detection, Virtual area(Appear/Disappear) *Some of the video analytics only works with people and vehicle detection

Business Intelligence	People counting, Queue management, Heatmap based on AI engine
Alarm I/O	2 configurable I/O ports, DC 12V output(Max. 50mA)
Alarm Triggers	Analytics, Network disconnect, Alarm input
Alarm Events	File upload via FTP and e-mail Notification via e-mail SD/SDHC/SDXC or NAS recording at event triggers Alarm output Handover Audio playback
Audio In	Selectable(mic in/line in) Supply voltage: 2.5VDC(4mA), Input impedance: 2K Ohm
Audio Out	Line out, Max. output level: 1Vrms
IR Viewable Length	40m(131.23ft), WiseIR

Network

Ethernet	Metal shielded RJ-45(10/100/1000 BASE-T)
Video Compression	H.265/H.264: Main/High, MJPEG
Audio Compression	G.711 u-law /G.726 Selectable G.726(ADPCM) 8KHz, G.711 8KHz G.726: 16Kbps, 24Kbps, 32Kbps, 40Kbps AAC-LC: 48Kbps at 16KHz
Smart Codec	Manual(Sea area), WiseStream II, WiseStreamIII (using AI engine)
Bitrate Control	H.264/H.265: CBR or VBR MJPEG: VBR
Streaming	Unicast(6 users) / Multicast Multiple streaming(Up to 5 profiles)
Protocol	IPv4, IPv6, TCP/IP, UDP/IP, RTP(UDP), RTP(TCP), RTCP, RTSP, NTP, HTTP, HTTPS, SSL/TLS, DHCP, FTP, SMTP, ICMP, SNMPv1/v2c/v3(MIB-2), ARP, DNS, DDNS, QoS, UPnP, Bonjour, LLDP, SRTP (TCP, UDP Unicast)
Security	HTTPS(SSL) Login Authentication Digest Login Authentication IP Address Filtering User access log 802.1X Authentication(EAP-TLS, EAP-LEAP) Device Certificate(Hanwha Techwin Root CA) TPM with FIPS 140-2 level2 Secure boot, Verify firmware forgery
Application Programming Interface	ONVIF Profile S/G/T SUNAPI(HTTP API) Wisenet open platform

General

Webpage Language	English, French, German, Spanish, Italian, Chinese, Korean, Russian, Japanese, Swedish, Portuguese, Czech, Polish, Turkish, Dutch, Hungarian, Greek
Edge Storage	Micro SD/SDHC/SDXC 2slots 512GB
Memory	4096MB RAM, 512MB Flash

Environmental & Electrical

Operating Temperature / Humidity	-50°C ~ +55°C(-58°F ~ +131°F) / Less than 90% RH * Start up should be done at above -30°C
Storage Temperature / Humidity	-50°C ~ +60°C(-58°F ~ +140°F) / Less than 90% RH
Certification	IP66/IP67/IP6K9K, IK10+, NEMA4X
Input Voltage	PoE+(IEEE802.3at), 12VDC
Power Consumption	PoE+: Max 19.50W, typical 16.00W 12VDC: Max 17.00W, typical 13.50W

Mechanical

Color / Material	White / Aluminum, Hard-coated dome bubble
RAL Code	RAL9003
Product Dimensions / Weight	Ø180x125mm(7.09x4.92"), Weight : 1.90Kg (4.19lb)
Compatible Conduit hole / Gangbox	3/4" (M25) Single, Double, 4" Octagon, Square
Hanging Mount (Dome)	SBP-187HMW

DORI (EN62676-4 standard)

Detect (25PPM/ 8PPF)	Wide: 30.5m(100.03ft) / Tele: 93.9m(307.95ft)
Observe (63PPM/ 19PPF)	Wide: 12.2m(40.01ft) / Tele: 37.5m(123.18ft)
Recognize (125PPM/ 38PPF)	Wide: 6.1m(20.01ft) / Tele: 18.8m(61.59ft)
Identify (250PPM/ 76PPF)	Wide: 3.0m(10.00ft) / Tele: 9.4m(30.79ft)



SSX-52 SERIES DURABLE SIREN/SIREN STROBE

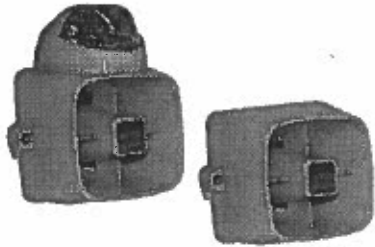

- Self-Contained /Indoor/Outdoor Siren and Siren/Strobe
- Sturdy aluminum back plate
- Strong polycarbonate housing
- Dual tamper protection
- 115dB sound output
- Warble sound output
- Mounts directly to wall or 4" square back box
- Strobe consists of colored mirror and lens
- Available strobe colors: Amber, blue, clear, red

The SSX-52 is a durable indoor/outdoor self-contained siren. The full featured siren consists of a single tone that delivers a warble sound output, 115dB @ 1 meter output siren driver, and a dual action reed plunger for cover and rear protection. The SSX-52 is provided with a strong polycarbonate housing and a sturdy aluminum back plate to prevent warping and cracking. The SSX-52 comes completely assembled and ready for installation.

The SSX-52S Siren-Strobe is also available. It includes all the great SSX-52 features with the addition of a colored strobe. The strobe uses a colored mirror and lens to ensure that the color can be easily distinguished, and is available in amber, blue, clear, or red.

The SSX-52/52S excels in noisy areas such as warehouses, loading docks, print shops, busy production floors, or for indoor/outdoor applications where high quality and high output warning is required.

Dimensions: Inches (mm)

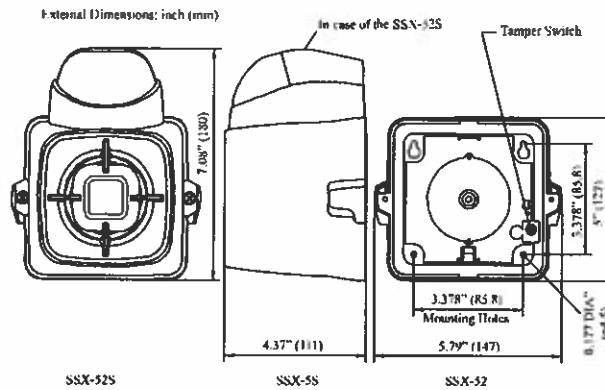

Model Number	Stock Number	Rated Voltage	Current Draw	Operating Voltage Range	Strobe Specifications			Speaker Specifications		Operating Temperature Range
					Lens Color	Strobe Candela Rating on Axis	Flash Rate	Sound Output	Tamper Contact Capacity	
SSX-52	4150024	6-12 VDC	620 mA Max.	4.8 - 14.4 VDC	-	-	-	115dB	0.3A @ 12V DC	-4°F to 149°F -20°C to 65°C
SSX-52SA	4150025	12 VDC	748 mA Max.	9.6 - 14.4 VDC	Amber	2.03 Min.	20 - 100 times/min.			
SSX-52SB	4150026				Blue	1.80 Min.				
SSX-52SC	4150027				Clear	3.08 Min.				
SSX-52SR	4150028				Red	.75 Min.				

Potter Electric Signal Co., LLC • St. Louis, MO • Cust Service: 866-240-1870 • Tech Support: 866-956-1211 • Canada 888-882-1833 • www.pottersignal.com