

MONTAGE[®] PLUS & MONTAGE[®] COMMERCIAL

Ornamental Steel Fence



FENCE PRODUCTS

AMERISTARPERIMETER.COM | 800-321-8724

Experience a safer and more open world

AMERISTAR[®]

ASSA ABLOY



MONTAGE PLUS & MONTAGE COMMERCIAL

ORNAMENTAL STEEL FENCE

Traversing varying grades, a variety of distinct product styles and unmatched coating performance, Montage Plus & Commercial fence systems are the preferred choice for ornamental fence.

PANEL BRACKET

Universal Boulevard Bracket enables easy installation while allowing for adjustment of panel height and positioning

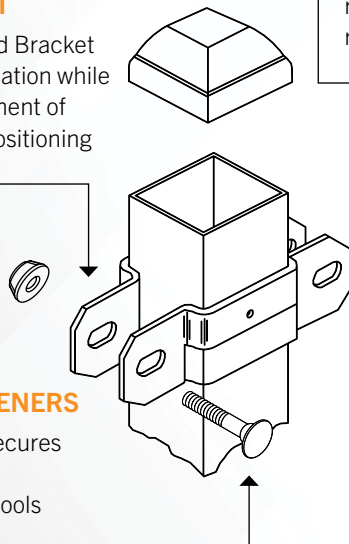

SECURITY FASTENERS

Security fastener secures the rail and deters removal by typical tools

PICKET TO RAIL PROFUSION WELDING

Each picket is welded precisely at each rail connection for ease of installation, yet remaining flexible as an all-terrain fence

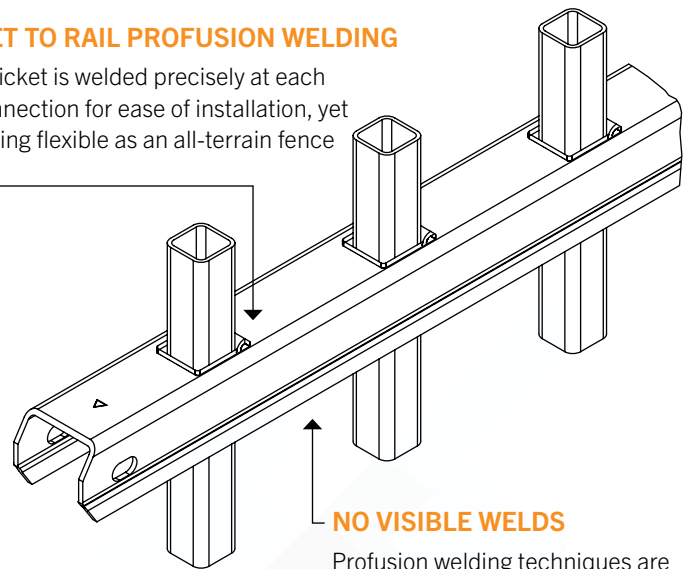

NO VISIBLE WELDS

Profusion welding techniques are both strong and hidden from view, providing a good neighbor profile

	PICKETS	RAILS	POSTS	HEIGHTS	COLOR
Plus	¾" SQ. x 18 GA.	1.5" x 1.5" x 14 GA.	2.5" SQ. x 16 GA.	3', 3½', 4', 5', 6'	BLACK
Commercial	¾" SQ. x 14 GA.	1.5" x 1.5" x 14 GA.	2.5" SQ. x 14 GA.	7', 8'	BLACK

ENVIRONMENTALLY RESPONSIBLE

We lead the way in manufacturing programs and practices that reduce our carbon footprint — monitoring air emissions, stormwater runoff and wastewater discharge and recycling all scrap steel, wood, cardboard, plastics, paper and oil products, giving our products the opportunity to earn project LEED points.



PROFUSION WELDING

Laser and fusion welding technology create a virtually invisible structural connection at every picket to rail intersection.



RAKEABLE VS STAIR-STEP

Fully rakeable panels eliminate any possible security risks due to large gaps under the fence panels.



FULLY RAKEABLE
PANELS



STAIR-STEPPING
PANELS

E-COAT™

20 YEAR WARRANTY

The Montage families of fencing products are manufactured from superior quality materials by skilled craftsmen with the highest standards of workmanship in the industry.

We are so confident in this product, it comes with a 20 year warranty.



PRE-TREATMENT

**ALKALINE
SPRAY WASH**

1

**ALKALINE
IMMERSION**

2

**WATER
IMMERSION**

3

**SPRAY
CONDITIONER**

4

**PHOSPHATE
IMMERSION**

5

EPOXY PROCESS

**ELECTRO COAT
EPOXY PRIMER**

10

**PERMEATE
SPRAY RINSE**

11

**PERMEATE
IMMERSION**

12

**PERMEATE
SPRAY RINSE**

13

**REVERSE OSMOSIS
HALO RINSE**

14

ACRYLIC FINISH

**ELECTRO COAT
ACRYLIC FINISH**

17

**PERMEATE
SPRAY RINSE**

18

**PERMEATE
IMMERSION**

19

**PERMEATE
SPRAY RINSE**

20

**REVERSE OSMOSIS
HALO RINSE**

21

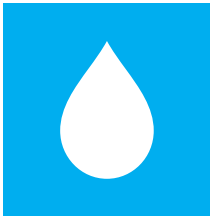
**WATER
IMMERSION**

6



**NON-CHROMATE
SPRAY SEAL**

7

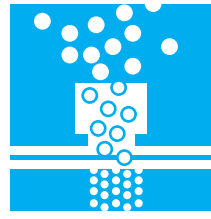

**REVERSE OSMOSIS
IMMERSION**

8



**REVERSE OSMOSIS
HALO RINSE**

9

Immersion processes coat and cleanse the inside of the fence components as thoroughly as the outside. This prevents corrosion, giving Montage products the ability to withstand the elements and be maintenance-free.



**FINISH CURING
OVEN**

15



**COOLING
TUNNEL**

16



**FINISH CURING
OVEN**

22



**COOLING
TUNNEL**

23

LAYERED PROTECTION

Protection against corrosion starts with a proven process, which is why Ameristar emulated its PermaCoat method to develop a superior E-Coat process that protects the product with complete coverage inside and out.

-  ACRYLIC TOPCOAT
-  EPOXY PRIMER
-  PHOSPHATE
-  GALVANIZED STEEL

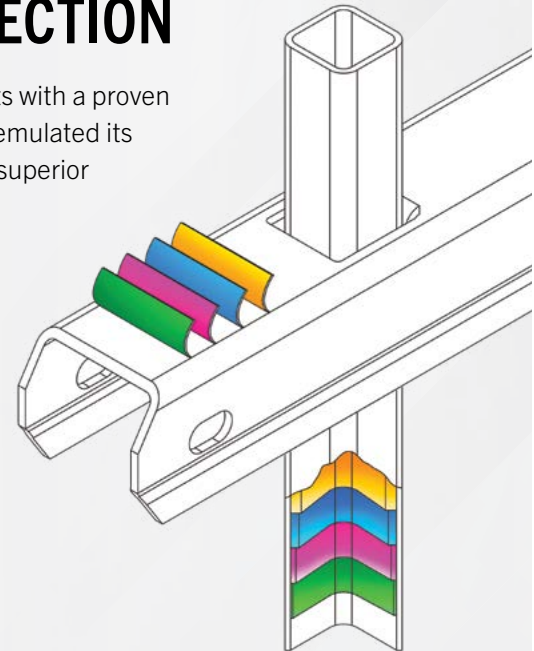



CLASSIC™

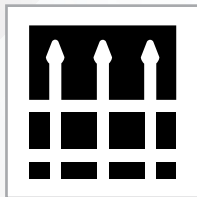

Experience traditional grace.

Extended pickets that culminate to an arrow-pointed spear capture the look of traditional wrought iron fencing. Single, double and arched gates are also available to match this style.



PANELS

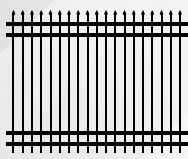

4-RAIL PANELS
Available in 7' & 8' heights

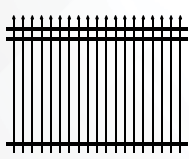

3-RAIL PANELS
Available in 3', 3½', 4', 5', 6', 7' & 8' heights

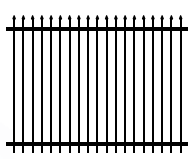

2-RAIL PANELS
Available in 3', 3½', 4', 5', & 6' heights

BOTTOM OPTION



STANDARD BOTTOM RAIL



FLUSH BOTTOM RAIL

PICKET SPACING



4" GAP
Standard



3" GAP



MAJESTIC™

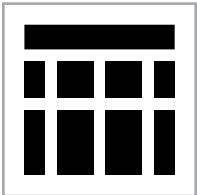

Enjoy sleek modernism.

The flush top rail projects a more modern, streamlined look, making it one of the most popular styles in the Montage family. Single, double and arched gates are also available to match this style.



PANELS

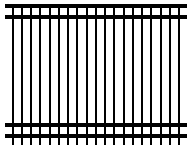

4-RAIL PANELS
Available in
7' & 8' heights

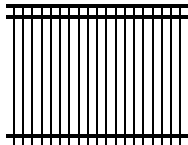

3-RAIL PANELS
Available in
3', 3½', 4', 5', 6',
7' & 8' heights

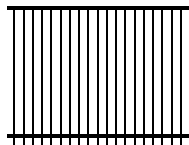

2-RAIL PANELS
Available in
3', 3½', 4', 5', & 6'
heights

BOTTOM OPTION



**STANDARD
BOTTOM
RAIL**



**FLUSH
BOTTOM
RAIL**

PICKET SPACING



4" GAP
Standard



3" GAP



GENESIS™

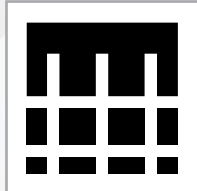

Customize your look.

The extended flat-topped pickets serve as a base for your choice of accent finials, providing a customized design. Single, double and arched gates are also available to match this style.

ADORNMENTS



PANELS

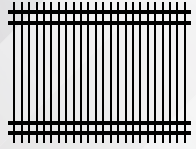

4-RAIL PANELS
Available in
7' & 8' heights

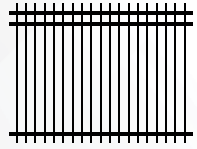

3-RAIL PANELS
Available in
3', 3½', 4', 5', 6',
7' & 8' heights

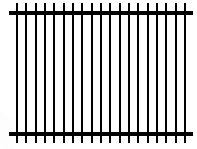

2-RAIL PANELS
Available in
3', 3½', 4', 5', & 6'
heights

BOTTOM OPTION



**STANDARD
BOTTOM
RAIL**



**FLUSH
BOTTOM
RAIL**

PICKET SPACING



4" GAP
Standard



3" GAP



WARRIOR™

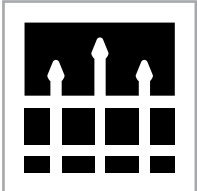

Capture definitive beauty.

Alternating picket heights topped with arrow-pointed spears give the Warrior a distinctive look indicative of wrought iron fencing. Single and double walk gates are also available to match this style.



PANELS

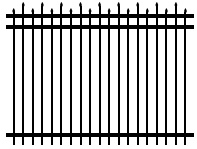

3-RAIL PANELS
Available in 3', 3½', 4', 5', & 6' heights

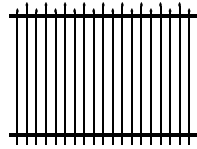

2-RAIL PANELS
Available in 3', 3½', 4', 5', & 6' heights

BOTTOM OPTION



STANDARD BOTTOM RAIL



FLUSH BOTTOM RAIL

PICKET SPACING



4" GAP
Standard



INVINCIBLE™

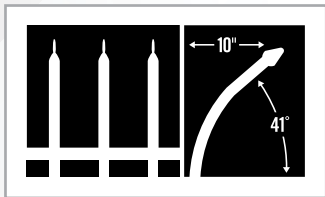

Gain intrepid fortification.

Pickets curve outward gracefully with a duality that acts as an attractive yet visually intimidating deterrent. Single and double gates are also available to match this style.

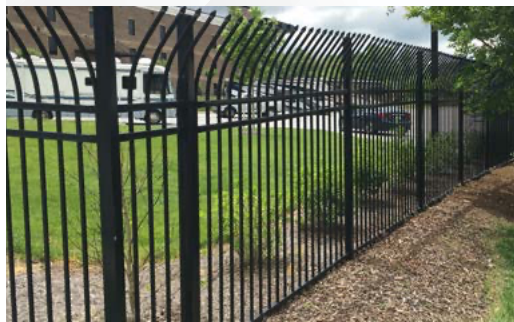

PANELS

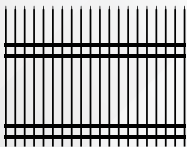

4-RAIL PANELS
Available in
7' & 8' heights

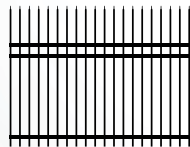

3-RAIL PANELS
Available in
7' & 8' heights

BOTTOM OPTION



**STANDARD
BOTTOM
RAIL**

PICKET SPACING



4" GAP
Standard



POOL, PET & PLAY

Relax in style.

Montage Plus and Montage Commercial Pool, Pet & Play provides additional safety and security with 3" airspace between pickets. This also provides increased panel strength due to the additional picket to rail connections.

PICKET SPACING



3" GAP



STYLES

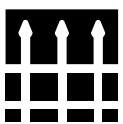

CLASSIC™



MAJESTIC™



GENESIS™

PANELS

Available heights

2-RAIL 3', 3-1/2', 4', 5', 6'

3-RAIL 3', 3-1/2', 4', 5', 6', 7', 8'

4-RAIL 7', 8'

BOTTOM OPTION



STANDARD
BOTTOM
RAIL



FLUSH
BOTTOM
RAIL

SWING GATES

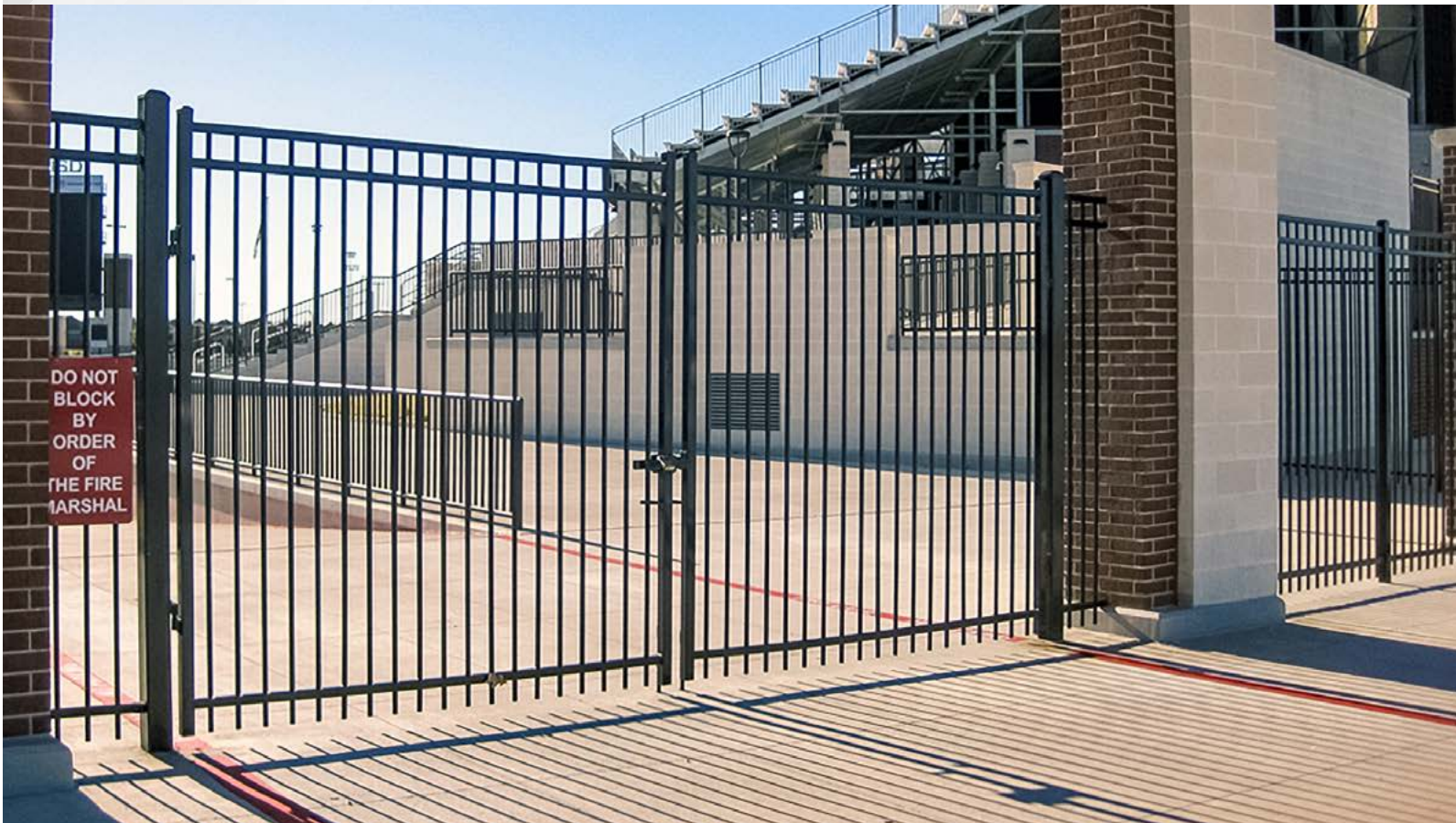

SINGLE AND DOUBLE SWING GATES

All swing gates are manufactured with the highest quality materials by skilled craftsmen and are fully welded for unparalleled strength and durability.



ARCHED GATES



SINGLE AND DOUBLE ARCHED GATES

Steel Estate Entry Gates are designed with a timeless elegance and are built to last with welded construction at every intersection. The one-of-a-kind compound arch provides a seamless transition from ornamental fence to decorative gate.

EXODUS GATES



- Meets IBC Group I-2 Egress Requirement
- Pre-assembled
- Quick Install



ALL-IN-ONE PEDESTRIAN GATE SYSTEM

Designed to mitigate multiple trips to the job site this all-in-one gate system has all required panic exit device hardware pre-installed and is available in both Single and Double Swing.



TRANSPORT® & PASSPORT® GATES

ENGINEERED CANTILEVER GATES

TransPort is a revolutionary cantilever gate system made up of three components: frame, facade and hardware. The component design decreases the risk of damage during transit and does not require a team of installers or machinery to install the gate system. The cantilever gate can easily be installed with a standard three-man crew in about two hours.



STEEL V-TRACK ROLL GATE DESIGN

PassPort is an innovative roll gate system with a robust fabricated design. Its rigid framework enables the gate system to glide effortlessly across its on-grade track, and its V-Track design provides the least amount of space required for a slide gate system. The reversible design of the PassPort roll gate insures a flawless installation by allowing the gate to be installed on either side of the gate opening.

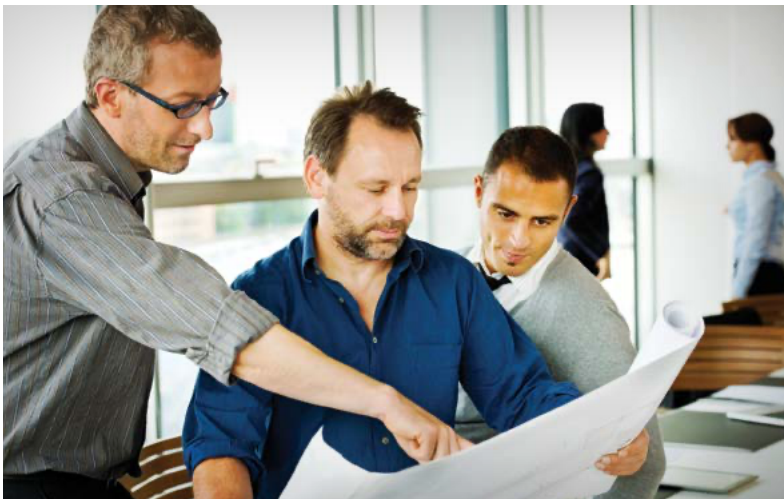

ARCHITECTURAL SUPPORT AND SOLUTION SPECIALISTS

Ameristar's Project Solution Specialists are experienced in every facet of perimeter security design. Our goal is to assist the architectural community in finding the best perimeter and entry solutions for their projects.

ameristarperimeter.com/architects

Why Choose Ameristar?

KNOWLEDGE AND EXPERIENCE

For over 40 years we've delivered aesthetically pleasing, high-quality and innovative fencing products with superior design strength and easy installation.

PROVEN CAPABILITIES

Our integrated in-house processes, extensive raw materials and finished goods inventory translate into quality, on-time delivery.

INDUSTRY LEADERSHIP

We continually raise the bar in manufacturing customer-focused solutions. Our high standards produce premium products that go beyond merely meeting minimum industry standards.

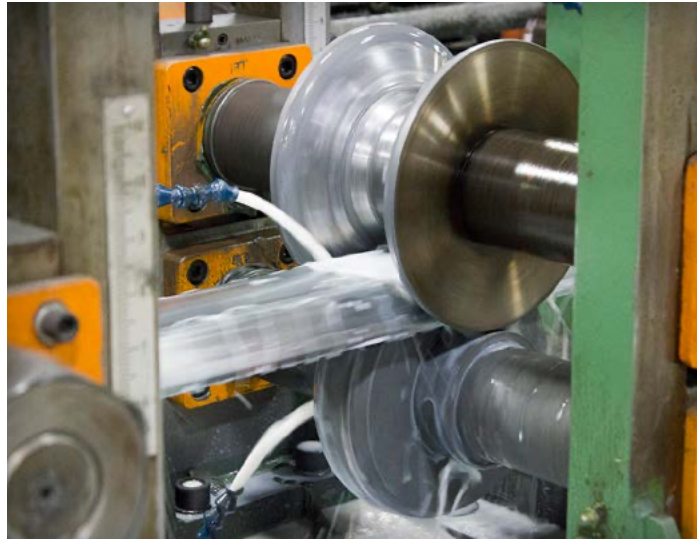

AMERISTARPERIMETER.COM | 800-321-8724

Experience a safer and more open world

#6015 | 2022

AMERISTAR[®]
ASSA ABLOY